

Outdoor Chairs & Lounge Chair

Contents

Before Use

General Guidelines.....	03
Warning.....	03
Material Properties.....	03

Installation Guide

Assembly Instructions.....	03
Parts List.....	04
Accessories List.....	05
Exploded Views.....	06
Installation Steps.....	08

Operation

Use & Maintenance.....	10
------------------------	----

General Guidelines

- Please read the following instructions carefully and use the product accordingly.
- Please keep this manual and hand it over when you transfer the product.
- It must be assembled and used according to the instructions. The seller does not accept any responsibility for damage or injury resulting from improper assembly or use.
- This summary may not include every detail of all variations and considered steps.
- Please contact us when further information and helps are needed.

Warning

- Children are not allowed to assemble the product.
- During assembly, keep any small part out of reach of children as they may be fatal if swallowed or inhaled.
- Children are not allowed to stand, climb or play on the product to avoid serious bodily injury by the toppling.
- Keep plastic packing bags out of reach of children to avoid any potential danger, such as suffocation.
- Avoid sharp objects and corrosive chemicals to prevent damage to the product or bodily injury.

Material Properties

1. Solid Wood

Trees will have a unique texture, scar, color and other natural marks during their growth. These elements constitute the natural beauty of wood. After being made into furniture, there will be slight discoloration when viewed under different light and different angles. That is because different grain minerals and light intensity affect vision, which is a normal phenomenon.

2. Marble and Sintered Stone

The pattern of marble and sintered stone is unique to each piece. Due to the characteristics of the material, there is no guarantee that the pattern of each piece will be consistent with the pattern seen at the time of purchase.

Assembly Instructions

· Read these instructions carefully and keep for future reference. Refer to parts inventory for guidance, and ensure you have all pieces before starting.

- **When assembling place all parts on a soft, clean, and flat surface such as a carpet to prevent scratches.**
- **During assembly, align all screws with the corresponding pre-drilled holes first and then tighten them one by one.**



TIME



2 People

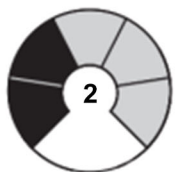

DIFFICULTY

Do not discard any contents until after assembly is complete to avoid accidentally discarding small parts or hardware.

TOOLS YOU MAY NEED

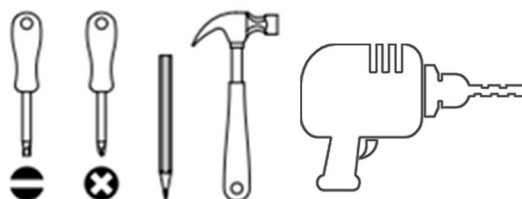

Note: It is recommended that installation of the product be done by a qualified licensed furniture assembler.

Parts List

Ax1

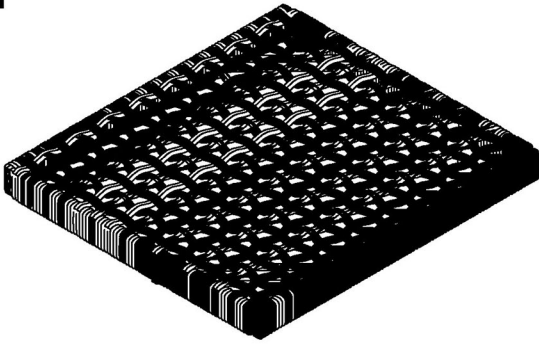

Bx1

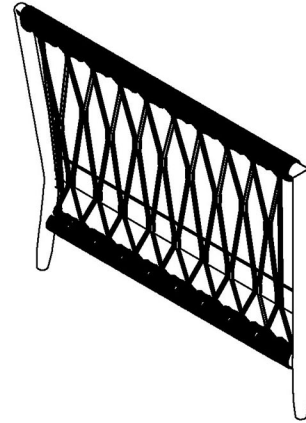

Cx1

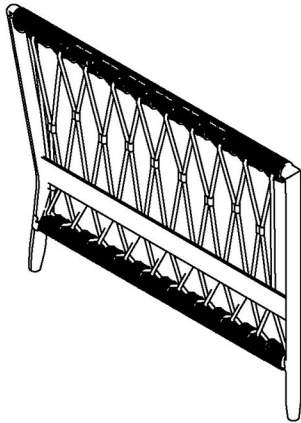

Dx1

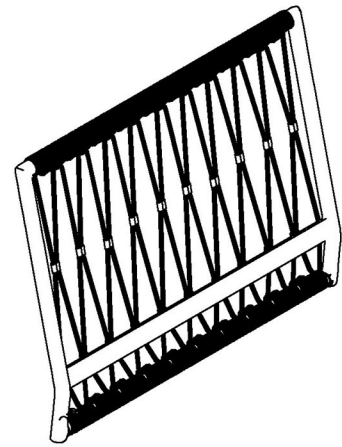

Ex1

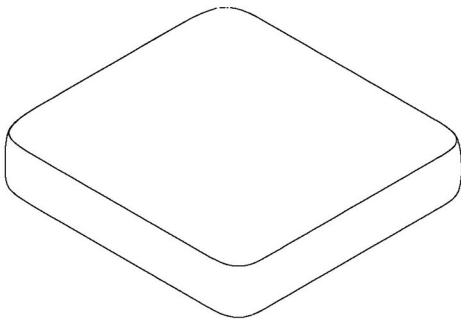

Fx1

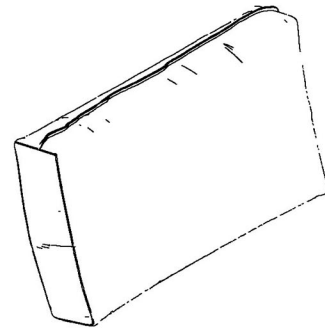

Accessories List

Gx1



M8*50mm

Hx6



M8*30mm

Ix1



Jx4



M8*40mm

Exploded Views

EXPLODED

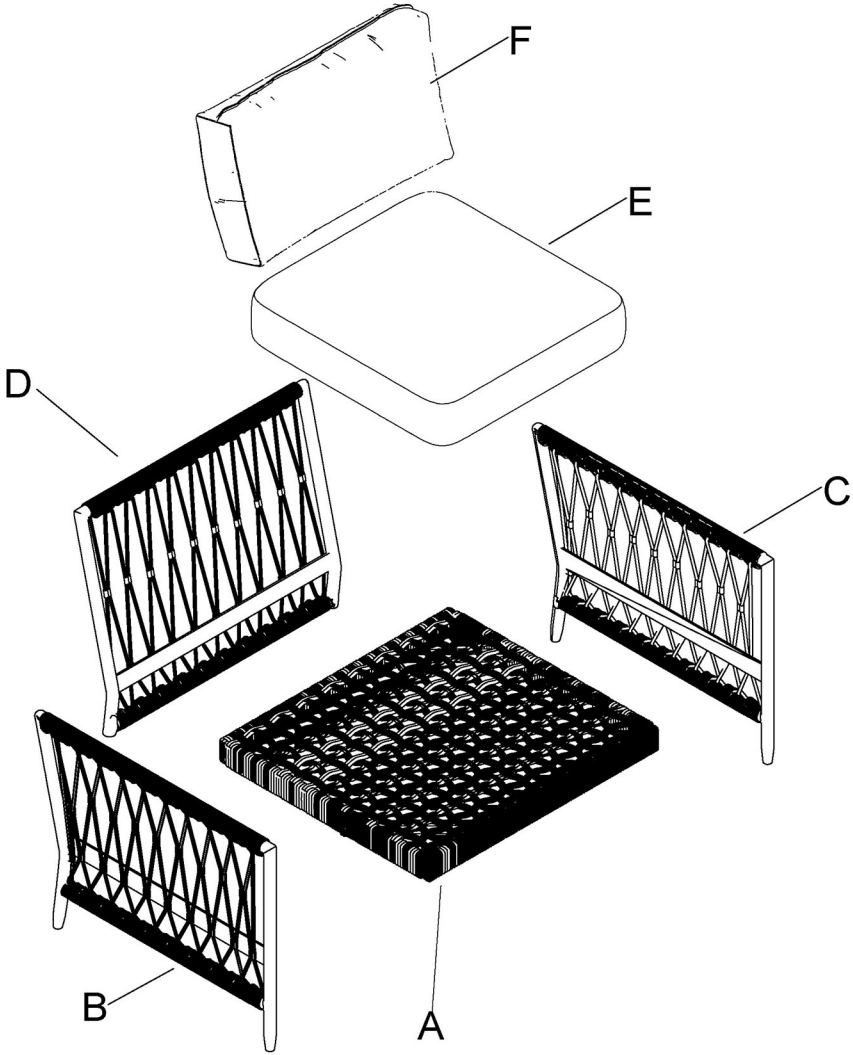

COMPLETE



Cam Lock Fastening System Installation

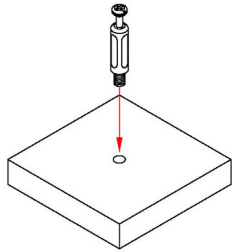

1. Install the screw rod

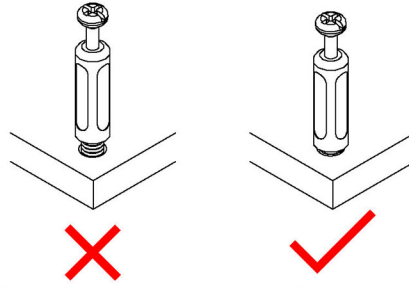

2. Pay attention to tightening the screw rod

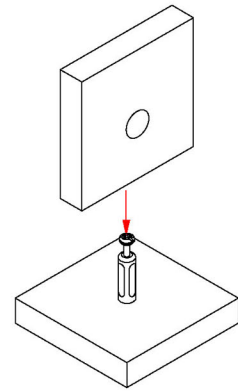

3. Installation plate

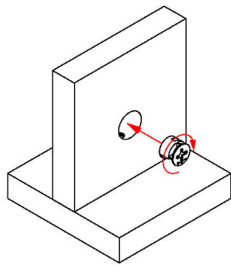

4. Align the arrow of the eccentric component with the screw rod

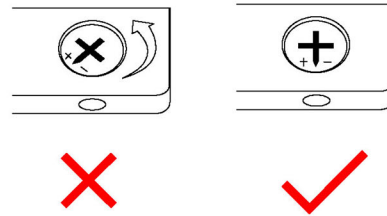

5. Pay attention to aligning the arrow of the eccentric part with the screw rod

Installation Steps

Step 1

G  x1

I  x1

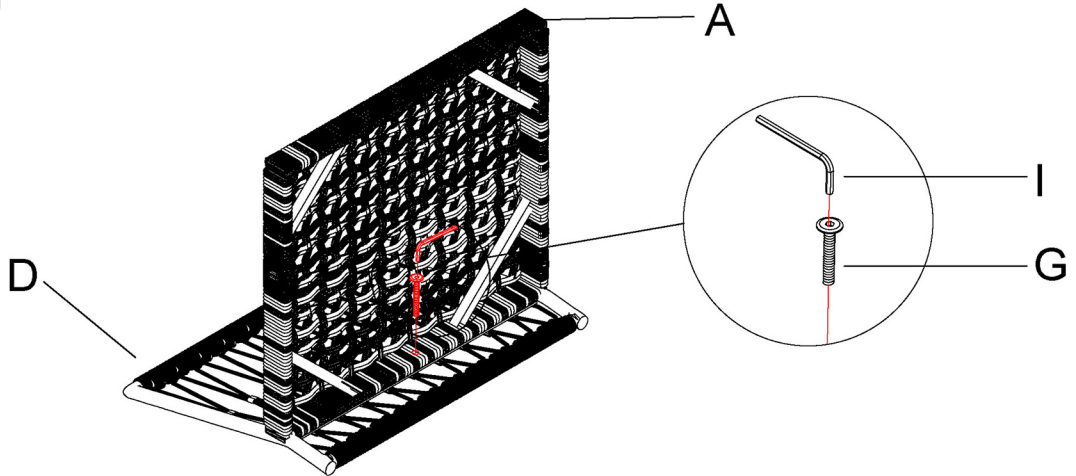

Step 2

H  x6

I  x1

J  x4

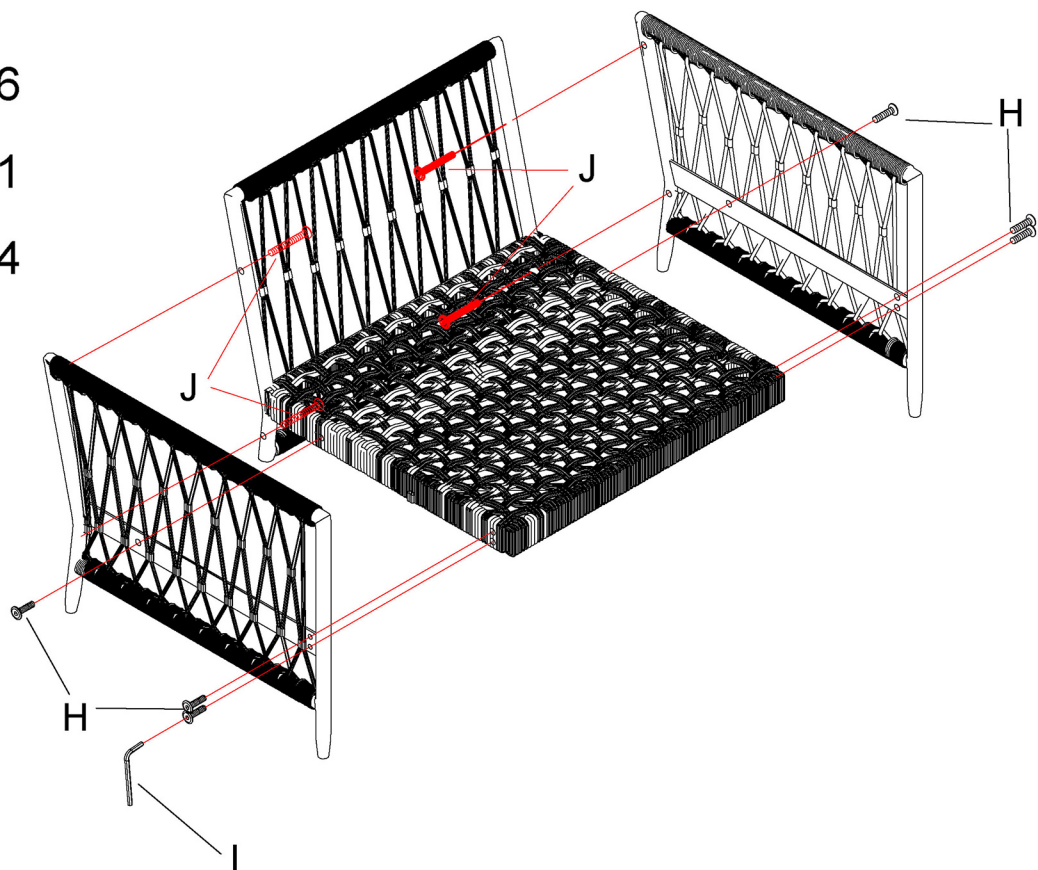

Installation Steps

Step 3

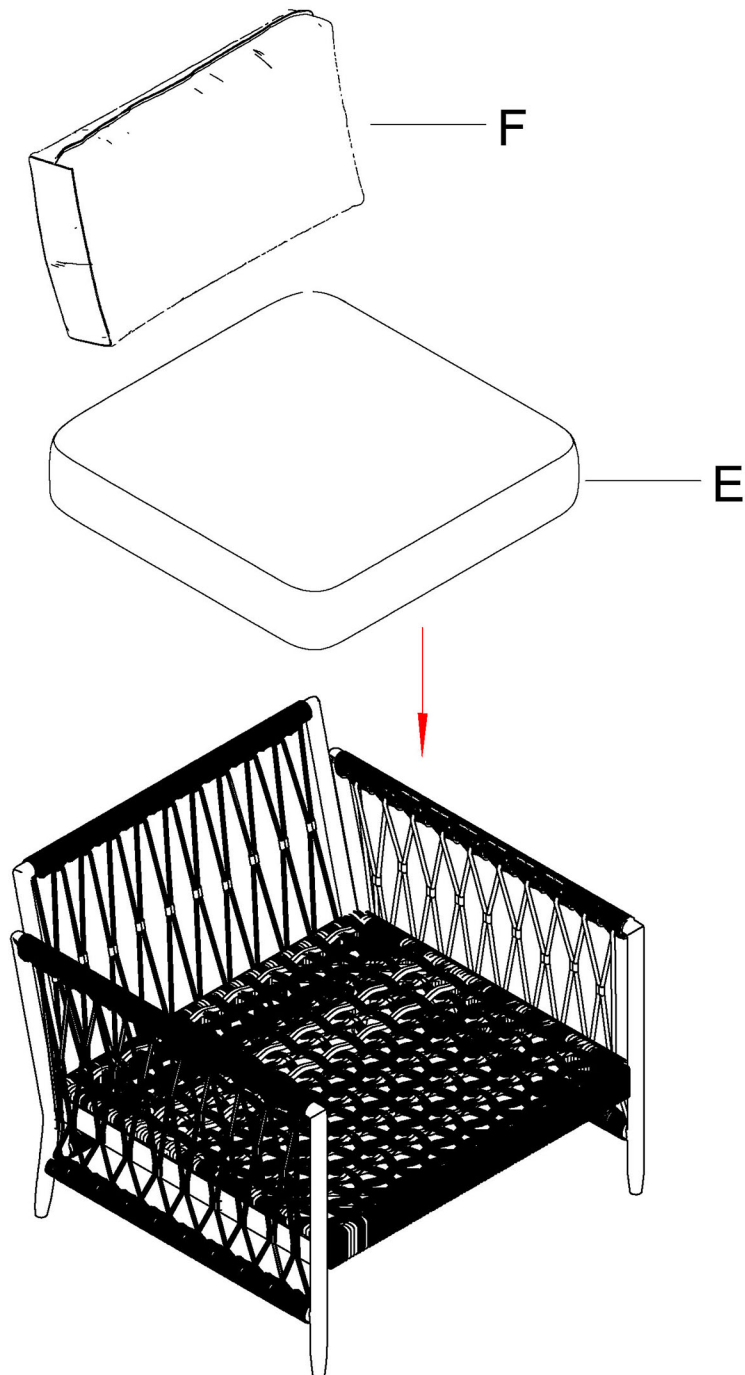

Use & Maintenance

1. Clean your outdoor furniture regularly to remove dirt, dust, and debris. Use a mild detergent and warm water to wash the furniture, and rinse thoroughly. Avoid using abrasive cleaners or materials that may damage the furniture's surface;
2. Teak furniture naturally weathers to a silver or gray patina over time. If you want to prevent your teak furniture from aging to a gray color, use a teak sealer/protector on an annual or bi-annual basis. Ensure that the furniture is clean and dry before applying the sealer.
3. Screws may become loose during long-term use. If necessary, re-tighten them to ensure stability and security.
4. A moist environment creates ideal conditions for mold and mildew growth. If possible, keep cushions or pillows under an umbrella, awning, or pergola. If possible, it's a good idea to store your furniture at the end of the season. If you're unable to store your furniture, make sure you buy covers that are designed to stand up to the rigors of the elements, which is especially vital if you live in a geographic location that receives harsh winters. During rainy days, bring all your cushions inside, they aren't built to weather storms. In case the cushion gets wet, make sure you let it fully dry before using it again.
5. Fluff vacuum-sealed cushions & pillows
Take the pillow out of its vacuum-sealed packaging carefully. Give the cushion/pillow a good shake to distribute the filling evenly. You can push in and out on all four sides of the pillow and massage the pillow to loosen up the filling and break up clumps. You can also put the pillow outside, the sunlight and fresh air can help fluff up the fillings.