

Dining Chairs & Benches Installation

Tools You Will Need: Tools You May Need

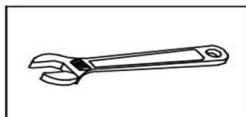

Adjustable wrench

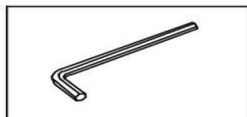

Hexagon wrench

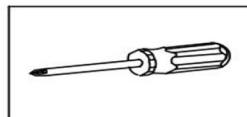

Philips Screwdriver

Before the Installation

1. Do not throw away packing materials until assembly is complete for small parts may come loose inside the carton during shipment. If parts are missing, please contact us.
2. Assemble this item on a soft surface, such as carpet to protect the finish.
3. Proper assembly of this item requires 2 people.
4. Periodically check to ensure that all connections are tight.
5. It is recommended that installation of the product be done by a qualified licensed furniture assembler.

Care and Cleaning

1. To protect the finish, avoid use chemicals and household cleaners.
2. All hot serving dishes should be placed on a pad.
3. Any liquid spilled onto the top should be cleaned up immediately with a damp cloth.

Parts List

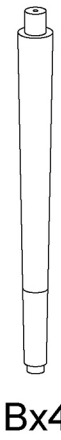
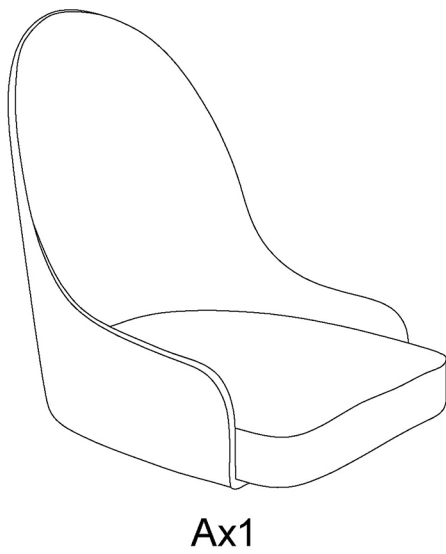
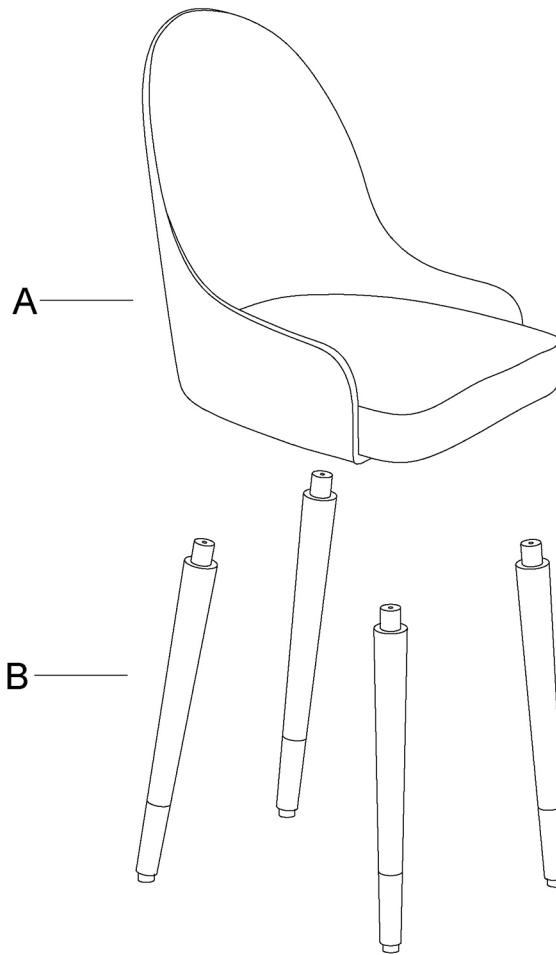

Step 1

P.3/3

C  x4

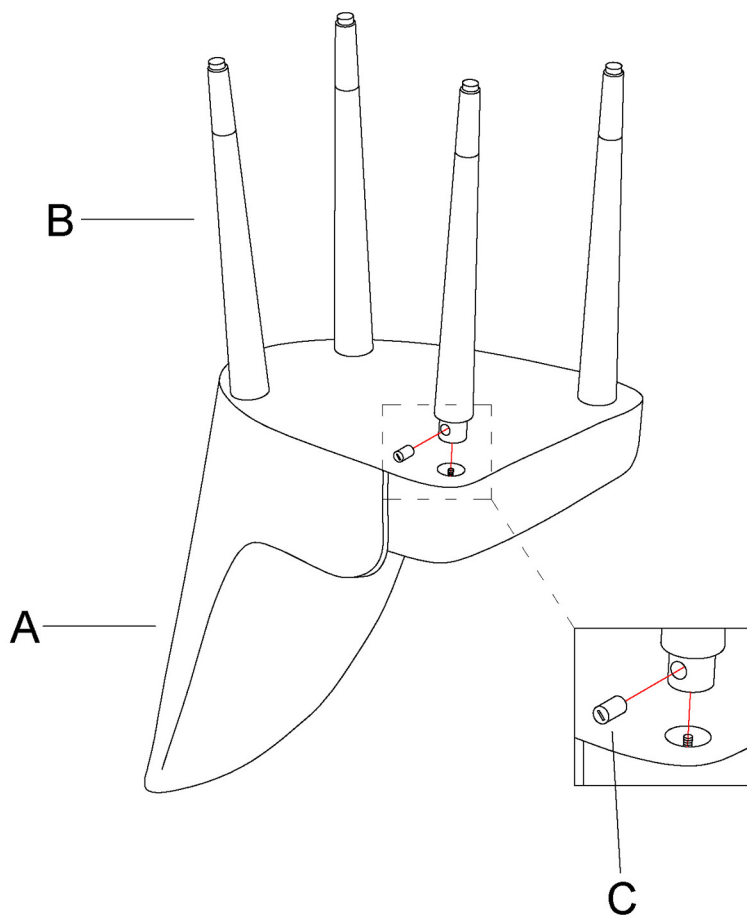

Step 2

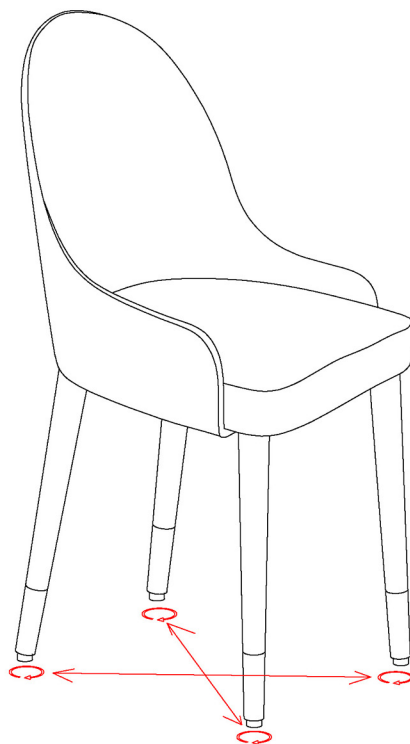

1. Firstly, put the installed chair on the horizontal ground, make sure the foot pads on four chair legs are in contact with the ground.
2. Secondly, if there is any foot pad on the chair legs not contacting with the ground, please rotate the foot pads out in a counterclockwise direction to ensure the contact and remain stable.