

Sofa #J040241 Installation

INSTALLATION MANUAL Tools You Will Need:

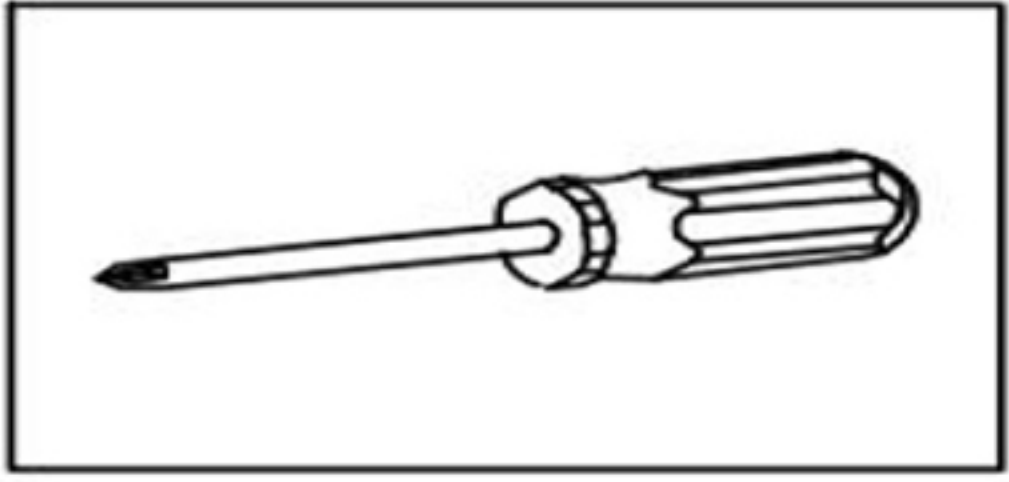

Philips Screwdriver

Before the Installation

1. Do not throw away packing materials until assembly is complete for small parts may come loose inside the carton during shipment. If parts are missing, please contact us.
2. Assemble this item on a soft surface, such as carpet to protect the finish.
3. Periodically check to ensure that all connections are tight.

Installation Guide

sofa (A x 1)

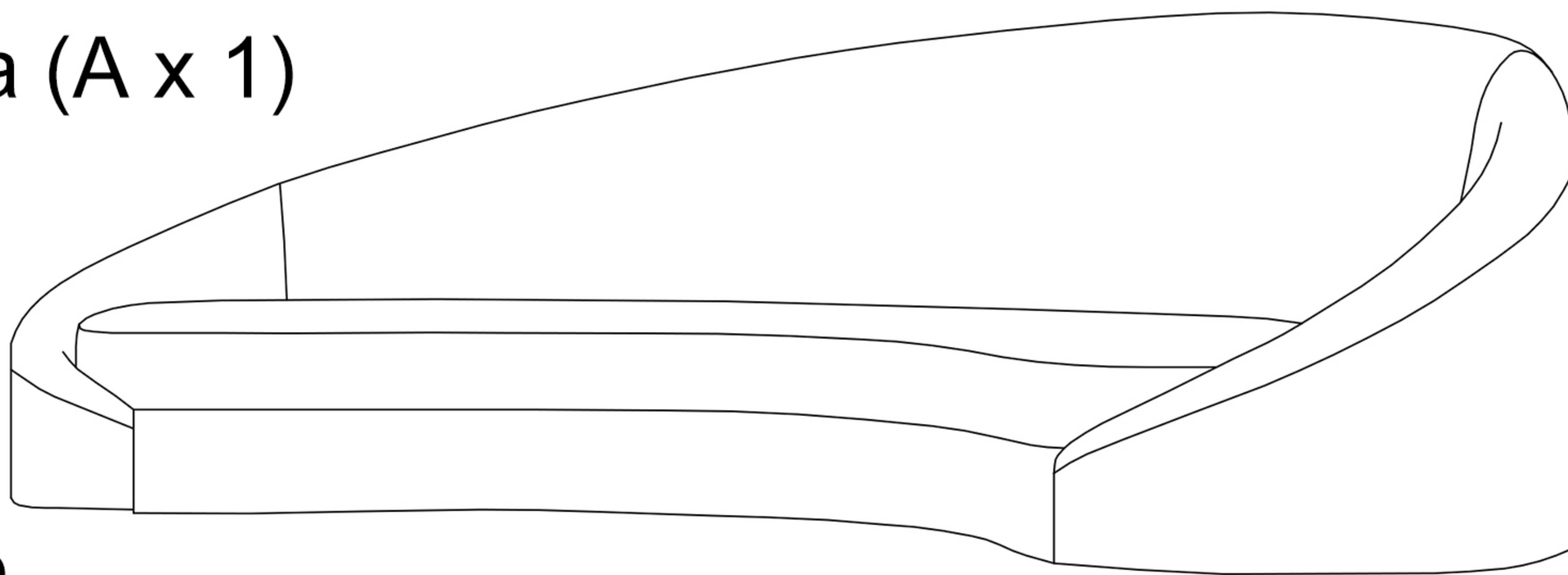

metal plate

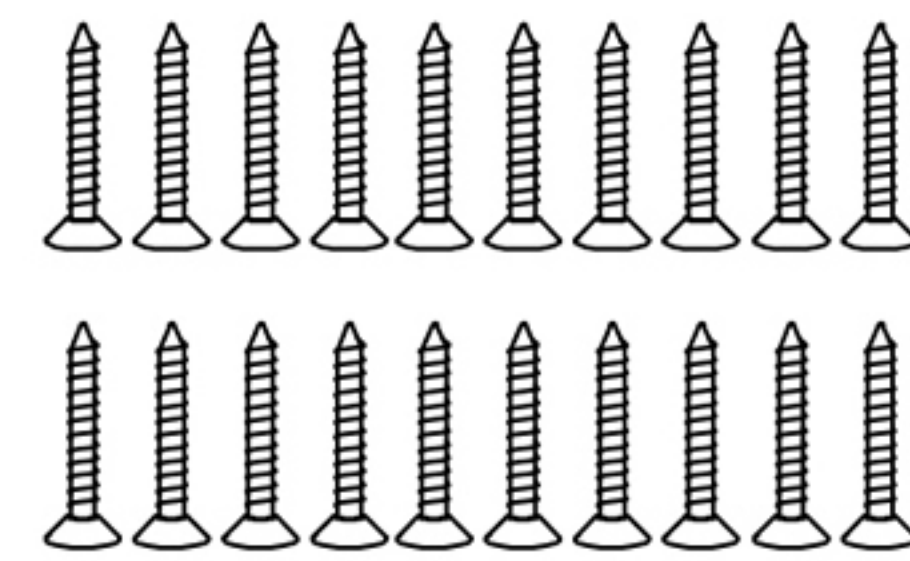
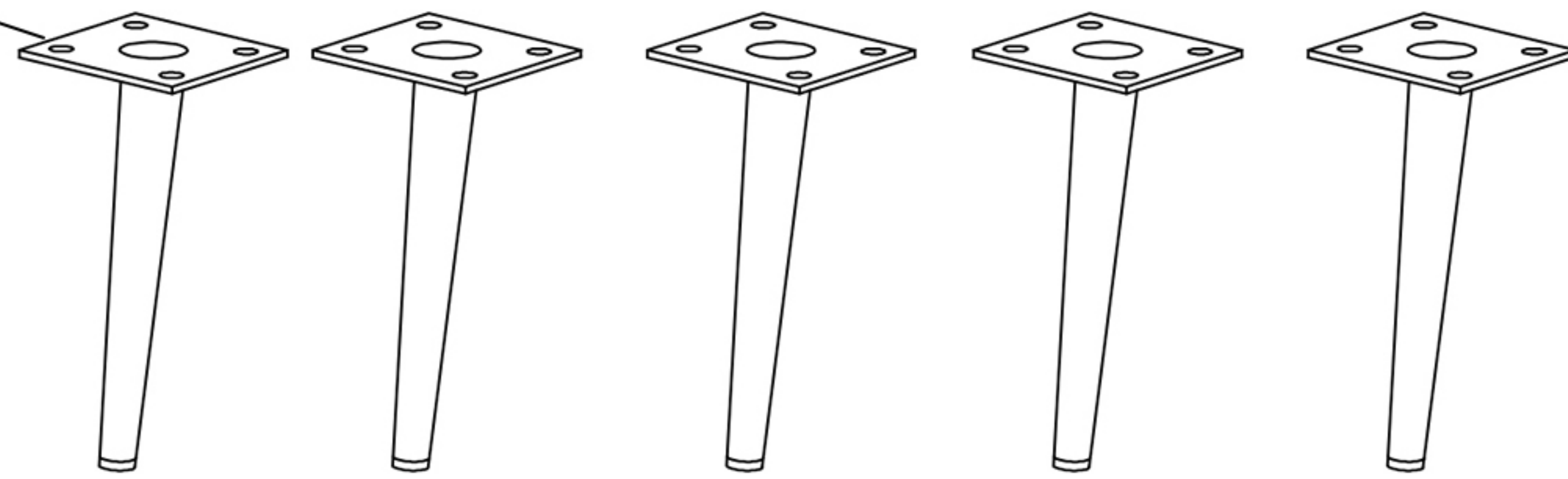

metal leg (C x 5)

screw (B x 20)

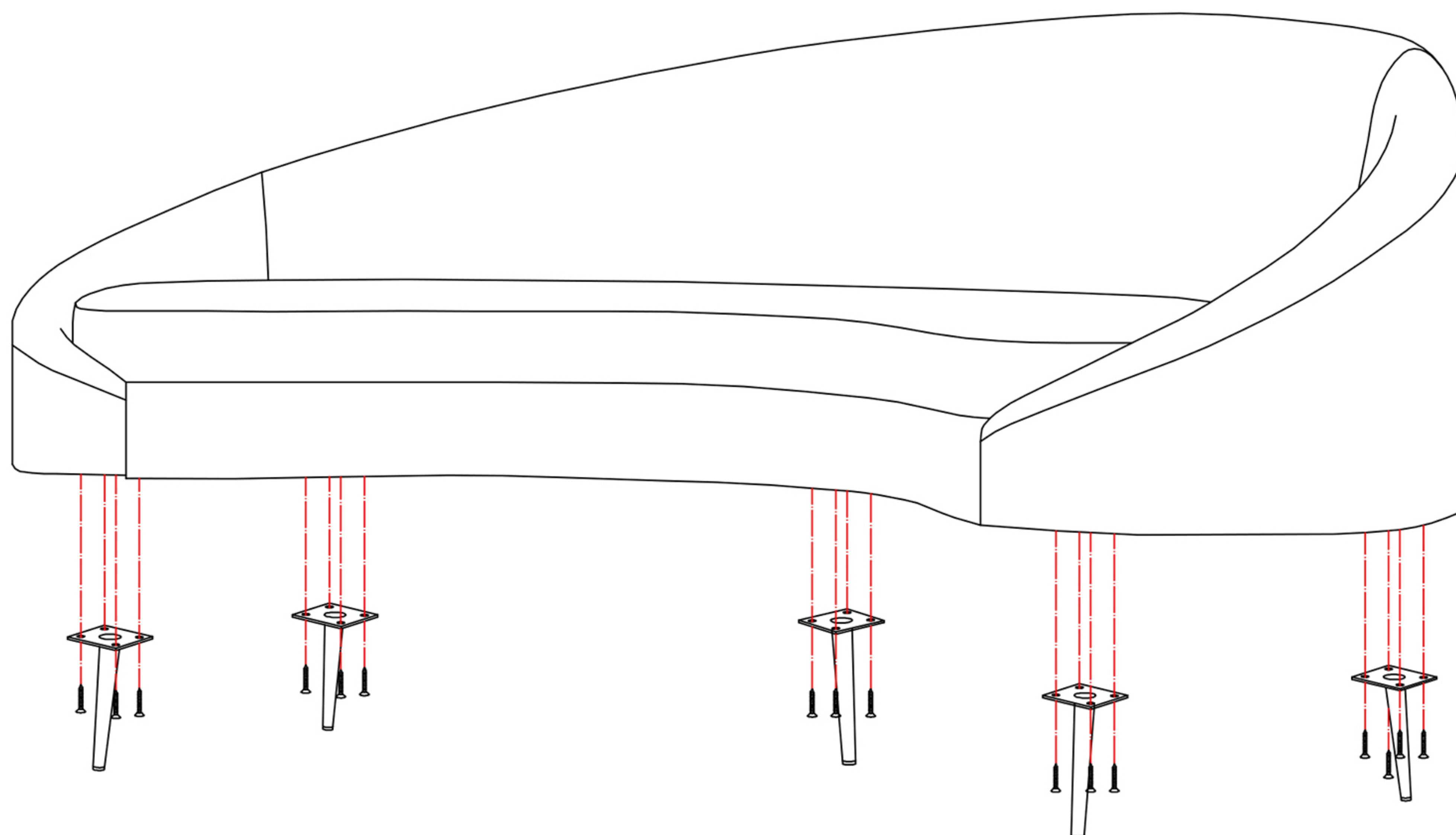

1. Align the slots of metal plate (C) with the sofa (A), fixing with screws (B).